

Crono

idea: *Pietro Lovato*



CRONO è una famiglia di sedute direzionali e semi-direzionali personalizzabile in ogni dettaglio. È una seduta che trasmette un'immagine di solidità e comfort allo stesso tempo, vincitrice del primo premio COMFORT SEATING 2011 nella sua categoria. Nella versione più accessoriata è provvista di schienale imbottito, poggiatesta e braccioli regolabili multidirezionali. La speciale manopola sul retro dello schienale permette una facile regolazione di quest'ultimo in modo da adattare l'altezza del supporto lombare alle specifiche esigenze.

CRONO is a family of executive and semi-executive chairs that can be customized in each detail. It is a seating that conveys an image of strength and comfort at the same time, winner of the first prize COMFORT SEATING 2011 in its category. The fully equipped version is equipped with upholstered backrest, headrest and multiadjustable armrests. The special handle on the back allows easy adjustment of the lumbar support according to the height of the end user.

CRONO est une famille de fauteuils de direction et semi-direction personnalisable dans chaque détail. C'est un siège qui transmet une image de robustesse et de confort au même temps ; il a remporté le premier prix COMFORT SEATING 2011 dans sa catégorie. Dans la version plus complète il est équipé de dossier rembourré, appuie-tête et accoudoirs multifonctions. La poignée sur le dossier permet un réglage facile de ce dernier afin de régler la hauteur du support lombaire selon les besoins de l'utilisateur.

CRONO ist eine Stuhlfamilie für Direktionsbereiche und sonstige Sekretariatsarbeiten, die in jedem Detail kundenspezifisch angepasst werden kann. Es handelt sich um einen Stuhl, der gleichzeitig ein solides und komfortables Aussehen überträgt. Crono wurde „COMFORT SEATING“ Preissieger in seiner Kategorie im Jahre 2011. Die meist ausgestattete Version ist mit gepolsterter Rückenlehne, verstellbare Kopfstütze und verstellbare Armlehnen. Der besondere Handgriff auf der Rückseite der Rückenlehne ermöglicht eine einfache Höhenverstellung der Rückenlehne um die Lumbalstütze anzupassen.

CRONO es una familia de sillas ejecutivas y semi-ejecutivas que se pueden personalizar en cada detalle. Es una silla que transmite una imagen de solidez y confort al mismo tiempo, ganadora del primer premio COMFORT SEATING 2011 en su categoría. La versión más equipada tiene un respaldo acolchado, reposacabezas y brazos ajustables multidireccionales. El botón especial en la parte posterior del respaldo permite un fácil ajuste de este último para adaptar la altura del soporte lumbar a las necesidades específicas.





_146

TOP COLLECTION



Crono

Girevole, imbottita, schienale regolabile in altezza, supporto lombare.

Swivel, upholstered, adj. backrest, lumbar support.

Pivotant, rembourré, dossier régl. en hauteur, soutien lombaire.

Drehbar, gepolstert, höhenverst. Rückenl., Lumbalstütze.

Giratoria, respaldo acolchado, regulable en altura, soporte lumbar.

147

Crono

versions
High
High+headrest

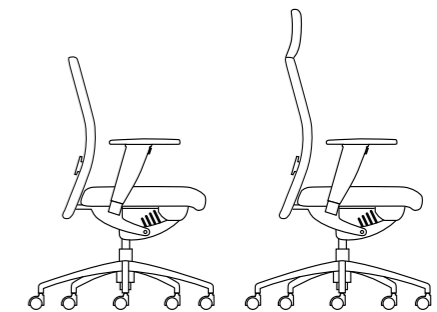

TOP COLLECTION

Crono

High+headrest



Crono /High+headrest
CR0040+XT002+XB084



Crono /High+headrest
CR0040+XT002+XB084

TOP COLLECTION

Crono

High+headrest



Crono /High+headrest
CR0026+XT002+XB002

_150



Crono /High
CR0040+XB084

151

Crono

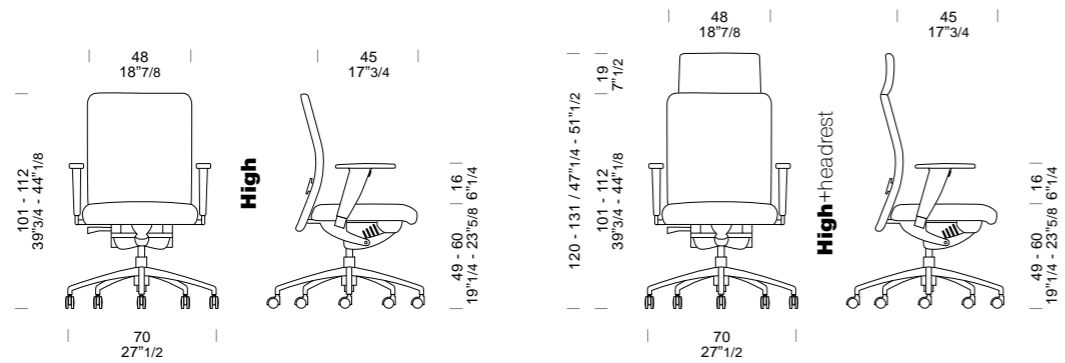

Crono

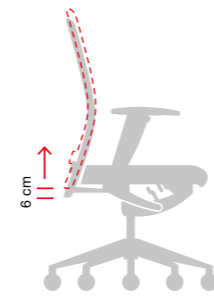

Schienale regolabile in altezza
 Height adjustable backrest
 Dossier réglable en hauteur
 Höhenverst. schwarz
 Respaldo ajustable en altura

SCHIENALE:

Schienale regolabile in altezza (6cm) in spugna schiumata a freddo con struttura portante in tubo tondo d'acciaio, Ø 20mm, con molle greche, rivestita.

BACKREST:

Height adjustable backrest (6cm) cold injected foam padding monocoque, Ø 20mm steel tube structure, with metal springs, upholstered.

DOSSIER:

Dossier réglable en hauteur (6cm) en mousse moulée à froids avec châssis en tube d'acier rond, Ø 20mm, ressorts nosag, tapissée.

RÜCKENLEHNE:

Kaltgeschäumte, höhenverst. Polyurethan Rückenl. (6cm). Ø 20mm Stahlrohr Struktur, Metallfedern.

RESPALDO: Respaldo ajustable en altura (6 cm) en espuma inyectada a frio con estructura de soporte en tubo de acero redondo, Ø 20 mm, resortes zig-zag, tapizado.



Project Wellness

A Pressione sullo schienale di spalle e scapole
 Shoulders and scapulas pressure on backrest
 Pression des épaules et omoplates sur le dossier
 Druck von der Schulter und Schulterblatt auf der Rückenlehne
 Presión en la parte posterior de los hombros y omóplatos

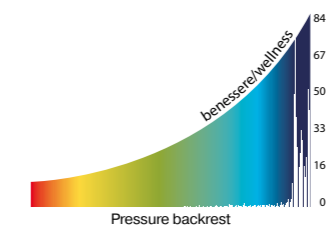

B Pressione dell'area sacrale su supporto lombare
 Sacrum pressure on lumbar support
 Pression sacrale sur le soutien lombaire
 Druck im Bereich Kreuzbein und Lendenwirbelstütze
 Presión del área sacra sobre soporte lumbar

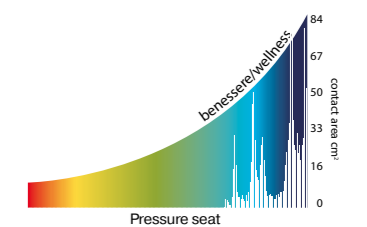

C Pressione di bacino e cosce sul sedile
 Hip and thigh pressure on seat
 Pression des cuisses et du bassin sur l'assise
 Druck im Becken und Oberschenkel auf dem Sitz
 Presión de pelvis y muslos en el asiento



5-spoke polished aluminium base



5-spoke black polyamide base



Ø 50 mm self-braking, black finish



Ø 50 mm soft self-braking, black finish



Ø 65 mm soft self-braking, black finish



XB091 - 2D
 XB092 - 3D



XB020 - 2D
 XB021 - 3D

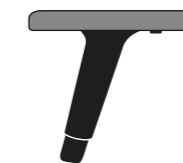

XB022 - 2D soft pad
 XB023 - 3D soft pad

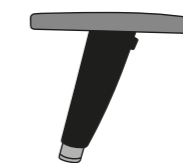

XB094 - chromed 2D soft pad
 XB087 - chromed 3D soft pad

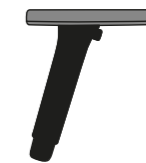

XB089 - 4D extra soft pad

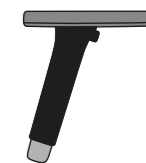

XB090 - chromed 4D extra soft pad



XB001 metal arm.

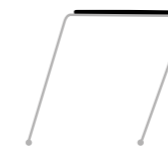

XB002 metal arm. uph. pad

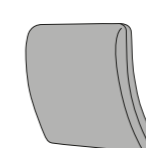

XT002 headrest



XD001 seat with springs

Per approfondimenti su meccanismi, braccioli e certificazioni consultare la sezione tecnica a pag. 24. / For further information on mechanisms, armrests and certifications, consult the technical section on page 24 / Pour plus d'informations sur les mécanismes, les accoudoirs et les certifications, consultez la section technique p. 24 / Weitere Informationen zu Mechanismen, Armlehnen und Zertifizierungen finden Sie im technischen Abschnitt auf Seite 24 / Para más información sobre mecanismos, brazos y certificaciones, consulte el apartado técnico en p. 24



ID 1111209675

